



DUB576	SCREW S/H CAP 6-32 X 3/4"	\$0.95
DUB577	SCREW S/H CAP 8-32 X 1/2"	\$0.40
DUB578	SCREW S/H CAP 8-32 X 3/4"	\$0.95
DUB579	SCREW S/H CAP 10-32 X 1/2"	\$0.95
DUB580	SCREW S/H CAP 10-32 X 3/4"	\$1.05
DUB581	SCREW S/H CAP 10-32 X 1"	\$1.05
DUB582	SCREW S/H CAP 10-32X1-1/4"	\$1.15
DUB583	SCREW S/H CAP 10-32X1-1/2"	\$1.25
DUB584	NUTS BLIND 10-32	\$1.00
DUB585	NUTS NYLON INS LOCK 10-32	\$1.05
DUB586	WASHERS FLAT #10	\$0.85
DUB587	WASHERS SPLIT #10	\$0.85

2 x 3/8 BUTTON HEAD SHEET METAL SCREWS



DUB525
\$1.65 8 pk.

DUB608	KWIK GRIP E-Z CONNECTOR	\$1.65
DUB609	KWIK GRIP E-Z CONN WRENCH	\$1.65
DUB611	LG SCALE FUEL VALVE (GAS)	\$18.45
DUB612	LG SCALE FUELING PROBE	\$1.90
DUB613	E/Z ADJUST AXLE 1-1/4X1/8	\$3.25

KWIK GRIP E-Z CONNECTOR

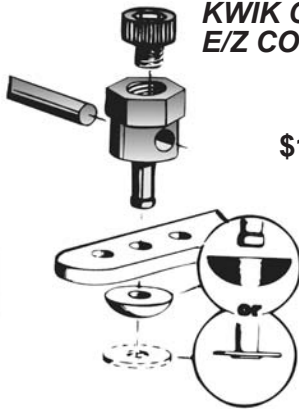

DUB608
\$1.65/ 2pk.

DUB614	E/Z ADJ AXLE 1 1/4X5/32	\$4.85
DUB615	E/Z ADJUST AXLE 2 X 5/32	\$4.90
DUB617	FUEL LINE PLUG	\$1.05
DUB618	RIGGING COUPLERS 4-40	\$2.95
DUB633	T-STYLE TAP HANDLE	\$6.20
DUB634	DOUBLE SIDED TAPE	\$2.40

1-1/4" X 5/32" E/Z ADJUST AXLE

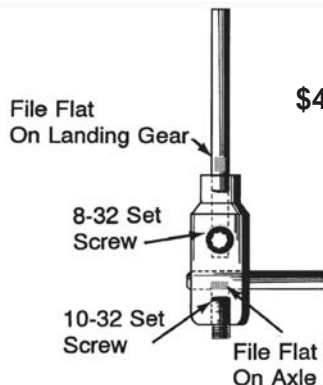

DUB614
\$4.85/ 2pk.

DUB635	WASHERS NYLON FLAT #4	\$0.95
DUB636	WASHERS NYLON FLAT #6	\$0.95
DUB637	WASHERS NYLON FLAT #8	\$0.95
DUB638	WASHERS NYLON FLAT #10	\$1.05
DUB639	WASHERS NYLON FLAT 1/4"	\$1.05
DUB645	SCREW S/H CAP 1/4-20 X 1"	\$1.40
DUB646	SCREW S/H CAP 1/4-20X 1.5	\$1.50
DUB647	SCREW S/H CAP 1/4-20 X 2"	\$1.65
DUB648	SCREW S/H CAP 1/4-20X2.5"	\$1.80

E/Z MOUNT STEERING ARM

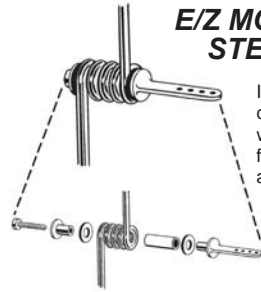

Installs on the spring coil of the nose gear with just one screw, and features a rubber shock-absorbing design.

DUB664
\$2.30

DUB649	SCREW S/H CAP 1/4-20 X 3"	\$1.95
DUB650	WASHERS FLAT 1/4-20	\$1.00
DUB651	WASHERS SPLIT 1/4-20	\$1.00
DUB652	NUTS NYL INS LOCK 1/4-20	\$1.15
DUB653	NUTS BLIND 1/4-20	\$1.05
DUB654	NUTS HEX 1/4-20	\$0.85
DUB655	MOTOR MOUNT .19-.50	\$23.75
DUB657	MOTOR MOUNT .50 - .90	\$29.75
DUB659	SPLIT COUP SLEEVE 4-40	\$1.00
DUB660	HINGE SLOTTER KIT	\$8.65
DUB662	LEADING EDGE TRIMMER	\$2.20
DUB664	E/Z MOUNT STEERING ARM	\$2.30

HEAVY DUTY SERVO ARMS

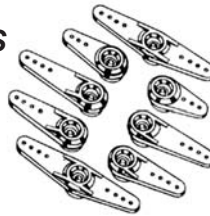

JR LONG	DUB671	\$10.75
FUTABA LONG	DUB670	\$10.75
HITEC LONG	DUB672	\$10.75
JR STANDARD	DUB674	\$8.60
FUTABA STAND.	DUB673	\$8.60
HITEC STAND.	DUB675	\$8.60

DUB665	4-STROKE THROTTLE LINKAGE	\$4.75
DUB666	KWIK START GLO PLUG IGNIT	\$18.85
DUB670	HD SERVO ARM FUT - LONG	\$10.75
DUB671	SERVO ARM H/D JR LONG	\$10.75
DUB672	HD SERVO ARM HITEC - LONG	\$10.75
DUB673	HD SERVO ARM FUT - STD	\$8.60
DUB674	HD SERVO ARM JR - STD	\$8.60
DUB675	HD SERVO ARM HITEC - STD	\$8.60

.40 - .46 MUFFLER EXTENSION

Fits the ASP, Magnum, O.S., and Thunder Tiger engines. Includes 2 3mm x 50mm screws. Distance between screws is 1 7/16 inches.

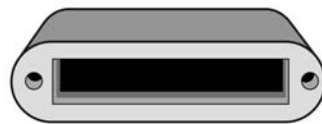

DUB699
\$5.40

DUB677	FUEL LINE CLIP MEDIUM	\$1.40
DUB678	FUEL LINE CLIP LARGE	\$1.40
DUB682	4-CYCLE MOTOR MNT 45-80	\$33.20
DUB684	MOTOR MOUNT .75-1.08 2STR	\$35.40
DUB686	4-CYCLE MOTOR MNT. 80-91	\$38.00

EXHAUST DEFLECTOR for .35 - .90 ENGINE



DUB697
\$3.90

DUB688	MOTOR MOUNT 1.20 - 1.80	\$40.50
DUB689	ELEMENTS F/684 686 688	\$13.05
DUB696	EXHAUST DEFLECTOR .20-.34	\$3.90
DUB697	EXHAUST DEFLECTOR .35-.90	\$3.90
DUB699	MUFFLER EXTENSION 40-46	\$5.40
DUB701	SOCKET WRENCH 4-WAY	\$6.45
DUB702	4-WAY SOCKET WRENCH XL	\$7.50

SCREW DRIVER & BALL DRIVER HOLDER

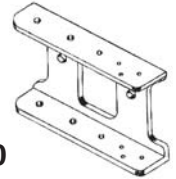

DUB704 \$4.50

DUB704	SCREW / BALL-DRIVER RACK	\$4.50
DUB705	6 PC.STD BALL DRIVER SET	\$18.00
DUB706	METRIC BALL DRIVER 5 PCE	\$18.00
DUB716	SUPER T-STYLE CONTRL HORN	\$1.55
DUB718	REBUILD KIT: 334 FUEL VLV	\$3.35
DUB720	REBUILD KIT: 610 FUEL VLV	\$4.49
DUB722	LEAK PROOF CAP E/Z PUMP	\$3.40
DUB725	E/Z THREADER	\$4.25

E/Z THREADER



DUB725
\$4.25

DUB783	Z-BENDER TOOL	\$20.55
DUB785	TUBING BENDER 1/8"	\$10.25
DUB786	TUBING BENDER 5/32"	\$13.35
DUB789	LANDING GEAR .35-.50	\$13.35
DUB792	PROFILE LANDING GEAR .40	\$9.95
DUB793	REMOTE SAFETY IGNITOR	\$9.50
DUB794	REMOTE SAFETY IGN RECESSD	\$9.50

DU-BRO Z-BENDER TOOL

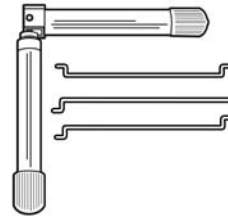

Makes true 90 degree bends on .072 inch push rods.

DUB783
\$20.55

DUB798	SCREW S/H CAP 3MMX50MM	\$1.50
DUB807	KWIKFILL FUEL CAN FITTING	\$8.20
DUB810	4-WAY WRENCH KLIP	\$3.05
DUB811	3/16" NYLON LNDG GEAR STP	\$1.20
DUB813	FUEL LINE BARB 1/8	\$1.30
DUB814	FUEL LINE BARB 5/32	\$1.55

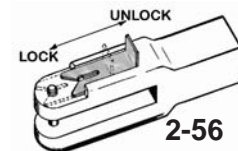

SAFE/LOCK KWIK LINK

2-56

#DUB815
\$2.00

DUB815	2-56 SAFE/LOCK KWIK LINK	\$2.00
DUB817	4-40 SAFE/LOCK KWIK LINK	\$2.00
DUB819	SAFETY LOCK KWIK-LINK 2MM	\$2.00
DUB837	STANDARD CLUNK	\$1.30
DUB845	MINI E/Z CONNECTOR	\$2.49
DUB846	PULL-PULL SYSTEM MICRO	\$7.95
DUB847	MICRO PUSHROD SYSTEM (2)	\$4.95
DUB848	MICRO CONTROL HORN	\$0.99
DUB849	MICRO E/Z LINK	\$1.25
DUB850	AILERON SYSTEM MICRO (2)	\$4.95
DUB851	BELL CRANK SYSTEM MICRO	\$1.25
DUB852	PUSH ROD SYSTEM 30" MICRO	\$5.95